

Pendant Light Fittings

BnD81 Series Explosion-proof Light Fittings



- ◆ Explosion protection to
 - CENELEC
 - IEC
 - NEC
- ◆ Can be used in
 - Zone 2
 - Zone 21 and Zone 22
 - Class I, Zone 2
 - Class I, Division 2, Groups A, B, C, D
- ◆ Available lamp (max.400W):
 - Metal halide lamp (HIE)
 - High pressure sodium lamp (HSE)
 - High pressure mercury lamp (HME)
- ◆ Three enclosure types: 150, 250, 400
- ◆ Integral control gear, easy installation and maintenance.
- ◆ Both American standard and European standard are available.

Catalogue number logic

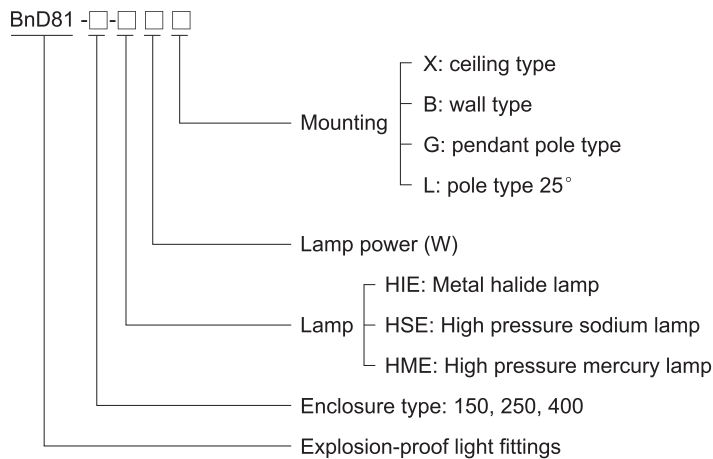

Selection table

Type/Ordering code	Available lamp power (W)			Lamp holder	Weight (kg)	
	HIE	HSE	HME		American standard	European standard
BnD81-150	70, 100, 150	70, 100	80, 125	E27 (E26)	8.05	6.15
BnD81-250	175, 250	150, 250	175, 250	E40 (E39)	13.00	10.20
BnD81-400	400	400	400	E40 (E39)	18.45	13.60

- Note:**
1. The light fittings are supplied without lamp. PHILIPS lamps are recommended.
 2. The light fittings are supplied without external reflector. Please specify when ordering.
 3. High pressure mercury lamp is not available in American standard products.

Zones 2; 21&22

Pendant Light Fittings

BnD81 Series Explosion-proof Light Fittings

Technical data			
Explosion-proof light fittings		BnD81-150-□□□	
Explosion protection	<p>Gas explosion protection $\text{Ex II 3 G Ex nR IIC T4 or T3 Gc}^{1)}$ Ex nR IIC T4 or T3 Gc¹⁾</p> <p>Dust explosion protection $\text{Ex II 2 D Ex tb IIIC T130}^{\circ}\text{C or T190}^{\circ}\text{C Db IP65}^{1)}$ Ex t IIIC T130°C or T190°C Db IP65¹⁾</p> <p>1) See Selection table</p>		
Certificates	LCIE 12 ATEX 1018X(gas); LCIE 12 ATEX 3093X(dust) IECEx CQM 12.0045X		
Conformity to standards	20150925-E477178(UL); 20151209-E477179(UL); CU-TR EN 60079-0, EN 60079-15, EN 60079-31 IEC 60079-0, IEC 60079-15, IEC 60079-31 UL 1598, CSA C22.2 No.250.0-8, UL 60079-0, UL 60079-15 CSA C22.2 No. 60079-0, CSA C22.2 No. 60079-15		
Material	Copper-free aluminium, powder coated surface, yellow (RAL1021)		
Enclosure	Toughened glass, stands 4J impact		
Transparent cover	Pure aluminium, anodic-oxidation treatment for surface		
External reflector (optional)	Powder coated carbon steel (white)		
Wire guard (optional)	Electromagnetic ballast, rapid starting, stable performance		
Ballast	General trigger		
Trigger	Power factor ≥ 0.90 (compensated)		
Capacitor	Stainless steel		
Exposed fastener	American Standard: E26; European Standard: E27		
Lamp			
Lamp holder			
Available lamp and lamp power (W)	Available lamp	American Standard	European Standard
		120V/208V/240V/277V/480V AC	220~240V, 250V AC
	HIE	70W, 100W, 150W	70W, 100W, 150W
	HSE	70W, 100W	70W, 100W
	HME	-	80W, 125W
Note: Please see Selection table of American standard HID lamp and corresponding electrical components (See P1/20)			
Rated voltage	American standard: 120V/208V/240V/277V/480V AC 60Hz (50Hz is optional) European standard: 220~240V AC 50Hz (60Hz is optional) 250V AC 50Hz (60Hz is optional)		
Earthing protection	M5 (internal & external earth bolts)		
Degree of protection	IP65		
Ambient temperature	ATEX / IECEx: -60°C~+55°C; UL: -60°C~+45°C		
Terminal	3 x 1.5~4mm ² (L+N+PE)		
Mounting	Ceiling type, wall type, pendant pole type, pole type 25°		
Cable entries	1 x M25 x 1.5		
Cable gland (optional)	DQM-I (Ex e) is recommended. Please see P7/16~19		



Selection table					
Rated power (W)		Temperature classes			
		-60°C ≤ Ta ≤ +40°C		-60°C ≤ Ta ≤ +55°C	
		Gas	Dust	Gas	Dust
European Standard	HIE 70W, 100W	T4	T130°C	T4	T130°C
	HIE 150W			T3	T190°C
	HME 80W			T4	T130°C
	HME 125W			T3	T190°C
	HSE 70W, 100W			T4	T130°C
American Standard	HIE 70W, 100W, 150W	T4	T130°C	T4	T130°C
	HSE 70W, 100W				

Pendant Light Fittings

BnD81 Series Explosion-proof Light Fittings

Photometric data

BnD81-150-□□□(Without external reflector)

Rated luminous flux

70W High pressure sodium lamp: 6600 lm
 100W High pressure sodium lamp: 10200 lm
 80W High pressure mercury lamp: 3800 lm
 125W High pressure mercury lamp: 6300 lm
 70W Metal halide lamp: 5000 lm
 100W Metal halide lamp: 9000 lm
 150W Metal halide lamp: 13500 lm
 The data from Philips lamp

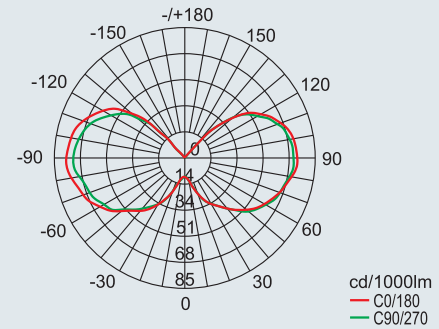

BnD81-150-□□□(With wide reflector)

Rated luminous flux

70W High pressure sodium lamp: 6600 lm
 100W High pressure sodium lamp: 10200 lm
 80W High pressure mercury lamp: 3800 lm
 125W High pressure mercury lamp: 6300 lm
 70W Metal halide lamp: 5000 lm
 100W Metal halide lamp: 9000 lm
 150W Metal halide lamp: 13500 lm
 The data from Philips lamp

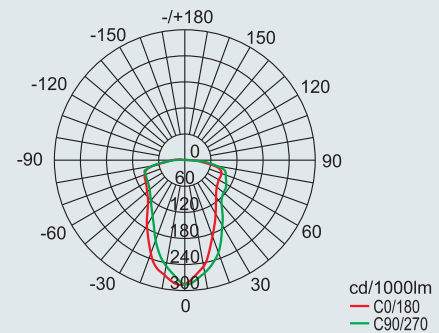

BnD81-150-□□□(With deep reflector)

Rated luminous flux

70W High pressure sodium lamp: 6600 lm
 100W High pressure sodium lamp: 10200 lm
 80W High pressure mercury lamp: 3800 lm
 125W High pressure mercury lamp: 6300 lm
 70W Metal halide lamp: 5000 lm
 100W Metal halide lamp: 9000 lm
 150W Metal halide lamp: 13500 lm
 The data from Philips lamp

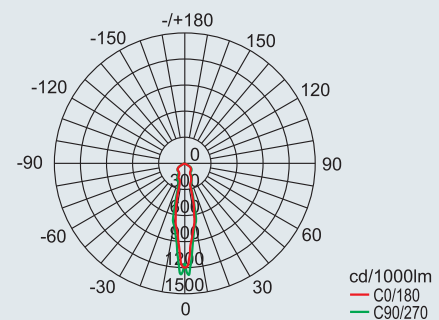

We can provide lighting design and data by professional lighting software DIALUX based upon simulated site situation on request.

Pendant Light Fittings

BnD81 Series Explosion-proof Light Fittings

Technical data																
Explosion-proof light fittings	BnD81-250-□□□															
Explosion protection	Gas explosion protection Ex II 3 G Ex nR IIC T3 Gc Dust explosion protection Ex II 2 D Ex t IIIIC T190°C Db IP65															
Certificates	LCIE 12 ATEX 1011X(gas); LCIE 12 ATEX 3044X(dust) IECEx CQM 12.0010X; 20150925-E477178(UL); 20151209-E477179(UL); CU-TR															
Conformity to standards	EN 60079-0, EN 60079-15, EN 60079-31 IEC 60079-0, IEC 60079-15, IEC 60079-31 UL 1598, CSA C22.2 No.250.0-8, UL 60079-0, UL 60079-15 CSA C22.2 No. 60079-0, CSA C22.2 No. 60079-15															
Material	Enclosure Copper-free aluminium, powder coated surface, yellow (RAL1021) Transparent cover Toughened glass, stands 4J impact External reflector (optional) Pure aluminium, anodic-oxidation treatment for surface Wire guard (optional) Powder coated carbon steel (white) Ballast Electromagnetic ballast, rapid starting, stable performance Trigger General trigger Capacitor Power factor ≥ 0.90 (compensated) Exposed fastener Stainless steel															
Lamp	Lamp holder American Standard: E39; European Standard: E40															
Available lamp and lamp power (W)	<table border="1"> <thead> <tr> <th rowspan="2">Available lamp</th> <th>American Standard</th> <th>European Standard</th> </tr> </thead> <tbody> <tr> <td>120V/208V/240V/277V/480V AC</td> <td>220~240V, 250V AC</td> </tr> <tr> <td>HIE</td> <td>175W, 250W</td> <td>175W, 250W</td> </tr> <tr> <td>HSE</td> <td>150W, 250W</td> <td>150W, 250W</td> </tr> <tr> <td>HME</td> <td>-</td> <td>175W, 250W</td> </tr> </tbody> </table>	Available lamp	American Standard	European Standard	120V/208V/240V/277V/480V AC	220~240V, 250V AC	HIE	175W, 250W	175W, 250W	HSE	150W, 250W	150W, 250W	HME	-	175W, 250W	
Available lamp	American Standard		European Standard													
	120V/208V/240V/277V/480V AC	220~240V, 250V AC														
HIE	175W, 250W	175W, 250W														
HSE	150W, 250W	150W, 250W														
HME	-	175W, 250W														
	Note: Please see Selection table of American standard HID lamp and corresponding electrical components (See P1/20)															
Rated voltage	American standard: 120V/208V/240V/277V/480V AC 60Hz (50Hz is optional) European standard: 220~240V AC 50Hz (60Hz is optional) 250V AC 50Hz (60Hz is optional)															
Earthing protection	M5 (internal & external earth bolts)															
Degree of protection	IP65															
Ambient temperature	ATEX / IECEx: -60°C~+55°C; UL: -60°C~+45°C															
Terminal	3 x 1.5~4mm ² (L+N+PE)															
Mounting	Ceiling type, wall type, pendant pole type, pole type 25°															
Cable entries	1 x M25 x 1.5															
Cable gland (optional)	DQM-I (Ex e) is recommended. Please see P7/16~19															



Pendant Light Fittings

BnD81 Series Explosion-proof Light Fittings

Photometric data

BnD81-250-□□□(Without external reflector)

Rated luminous flux

175W Metal halide lamp: 16000 lm

250W Metal halide lamp: 23500 lm

250W High pressure sodium lamp: 33200 lm

175W High pressure mercury lamp: 7350 lm

250W High pressure mercury lamp: 13000 lm

The data from Philips lamp

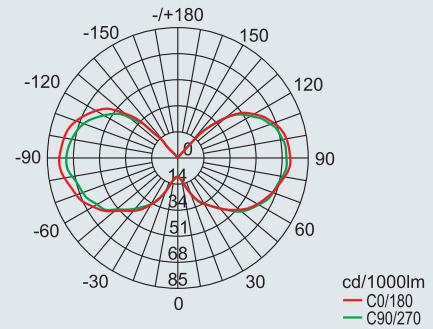

BnD81-250-□□□(With wide reflector)

Rated luminous flux

175W Metal halide lamp: 16000 lm

250W Metal halide lamp: 23500 lm

250W High pressure sodium lamp: 33200 lm

175W High pressure mercury lamp: 7350 lm

250W High pressure mercury lamp: 13000 lm

The data from Philips lamp

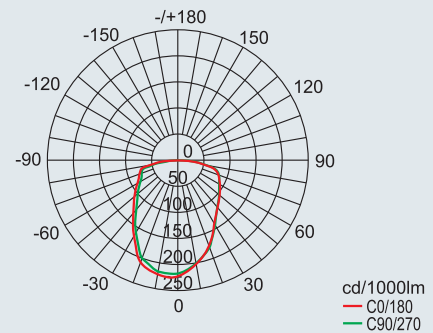

BnD81-250-□□□(With deep reflector)

Rated luminous flux

175W Metal halide lamp: 16000 lm

250W Metal halide lamp: 23500 lm

250W High pressure sodium lamp: 33200 lm

175W High pressure mercury lamp: 7350 lm

250W High pressure mercury lamp: 13000 lm

The data from Philips lamp

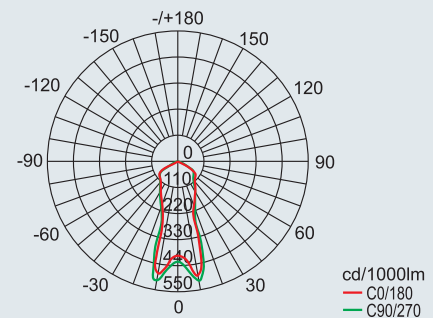

We can provide lighting design and data by professional lighting software DIALUX based upon simulated site situation on request.

Pendant Light Fittings

BnD81 Series Explosion-proof Light Fittings

Technical data																						
Explosion-proof light fittings		BnD81-400-□□□																				
Explosion protection		$\text{Ex II 3 G Ex nR IIC T}\square^{1)} \text{ Gc}$ $\text{Ex nR IIC T}\square^{1)} \text{ Gc}$ $\text{Ex II 2 D Ex tb IIIC T}\square^{1)} \text{ Db IP65}$ $\text{Ex t IIIC T}\square^{1)} \text{ Db IP65}$ 1) See Selection Table																				
Certificates		LCIE 12 ATEX 1019X(gas); LCIE 12 ATEX 3094X(dust)																				
Conformity to standards		IECEX CQM 12.0039X; 20150925-E477178(UL); 20151209-E477179(UL); CU-TR EN 60079-0, EN 60079-15, EN 60079-31 IEC 60079-0, IEC 60079-15, IEC 60079-31 UL 1598, CSA C22.2 No.250.0-8, UL 60079-0, UL 60079-15 CSA C22.2 No. 60079-0, CSA C22.2 No. 60079-15																				
Material		Copper-free aluminium, powder coated surface, yellow (RAL1021)																				
Enclosure		Toughened glass, stands 4J impact																				
Transparent cover		Pure aluminium, anodic-oxidation treatment for surface																				
External reflector (optional)		Powder coated carbon steel (white)																				
Wire guard (optional)		Electromagnetic ballast, rapid starting, stable performance																				
Ballast		General trigger																				
Trigger		Power factor ≥ 0.90 (compensated)																				
Capacitor		Stainless steel																				
Exposed fastener																						
Lamp		American Standard: E39; European Standard: E40																				
Lamp holder																						
Available lamp and lamp power (W)		<table border="1"> <thead> <tr> <th rowspan="2">Available lamp</th> <th colspan="2">American Standard</th> <th>European Standard</th> </tr> <tr> <th colspan="2">120V/208V/240V/277V/480V AC</th> <th>220~240V, 250V AC</th> </tr> </thead> <tbody> <tr> <td>HIE</td> <td colspan="2">400W</td> <td>400W</td> </tr> <tr> <td>HSE</td> <td colspan="2">400W</td> <td>400W</td> </tr> <tr> <td>HME</td> <td colspan="2">-</td> <td>400W</td> </tr> </tbody> </table>		Available lamp	American Standard		European Standard	120V/208V/240V/277V/480V AC		220~240V, 250V AC	HIE	400W		400W	HSE	400W		400W	HME	-		400W
Available lamp	American Standard		European Standard																			
	120V/208V/240V/277V/480V AC		220~240V, 250V AC																			
HIE	400W		400W																			
HSE	400W		400W																			
HME	-		400W																			
Rated voltage		Note: Please see Selection table of American standard HID lamp and corresponding electrical components (See P1/20) American standard: 120V/208V/240V/277V/480V AC 60Hz (50Hz is optional) European standard: 220~240V AC 50Hz (60Hz is optional) 250V AC 50Hz (60Hz is optional)																				
Earthing protection		M5 (internal & external earth bolts)																				
Degree of protection		IP65																				
Ambient temperature		ATEX / IECEx: $-60^{\circ}\text{C}\sim+55^{\circ}\text{C}$; UL: $-60^{\circ}\text{C}\sim+45^{\circ}\text{C}$																				
Terminal		3 x 1.5~4mm ² (L+N+PE)																				
Mounting		Ceiling type, wall type, pendant pole type, pole type 25°																				
Cable entries		1 x M25 x 1.5																				
Cable gland (optional)		DQM-I (Ex e) is recommended. Please see P7/16~19																				



Selection table					
Rated power (W)		Temperature classes			
		$-60^{\circ}\text{C}\leq\text{Ta}\leq+40^{\circ}\text{C}$		$-60^{\circ}\text{C}\leq\text{Ta}\leq+55^{\circ}\text{C}$	
		Gas	Dust	Gas	Dust
European Standard	HIE 400W	T3	T190°C	T3	T190°C
	HSE 400W				
	HME 400W			T212°C	T212°C
American Standard	HIE 400W	T3	T190°C	T3	T190°C
	HSE 400W	T4	T130°C		

Pendant Light Fittings BnD81 Series Explosion-proof Light Fittings

Photometric data

BnD81-400-□□□(Without external reflector)



Rated luminous flux
 400W Metal halide lamp: 41000 lm
 400W High pressure sodium lamp: 56500 lm
 400W High pressure mercury lamp: 22000 lm
 The data from Philips lamp

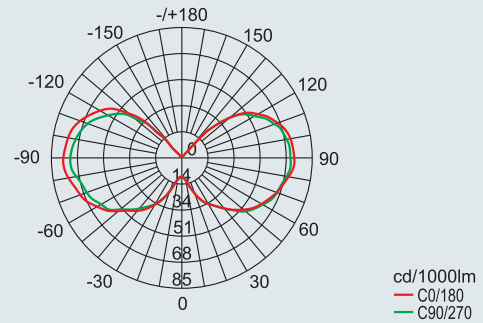

BnD81-400-□□□(With wide reflector)



Rated luminous flux
 400W Metal halide lamp: 41000 lm
 400W High pressure sodium lamp: 56500 lm
 400W High pressure mercury lamp: 22000 lm
 The data from Philips lamp

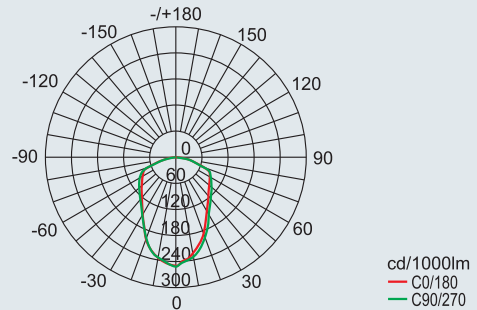

BnD81-400-□□□(With deep reflector)



Rated luminous flux
 400W Metal halide lamp: 41000 lm
 400W High pressure sodium lamp: 56500 lm
 400W High pressure mercury lamp: 22000 lm
 The data from Philips lamp

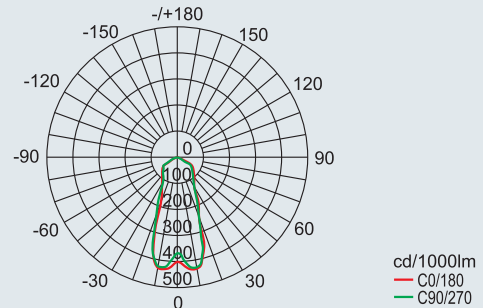

We can provide lighting design and data by professional lighting software DIALUX based upon simulated site situation on request.

Dimension drawings (all dimensions in mm) - subject to alteration

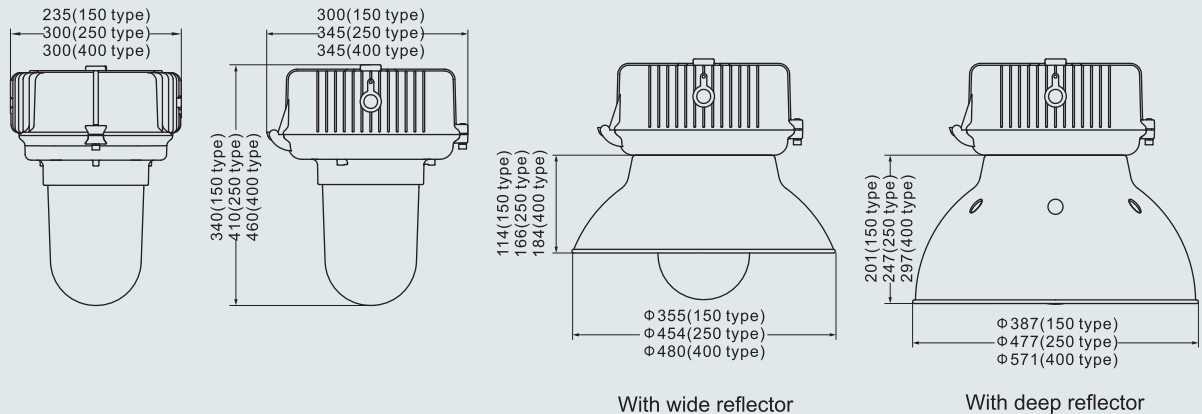

Pendant Light Fittings BnD81 Series Explosion-proof Light Fittings

Mounting type (all dimensions in mm) – subject to alteration

Installation reference

X: ceiling type

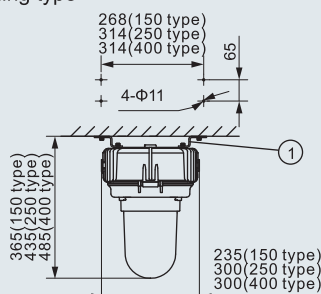

B: wall type

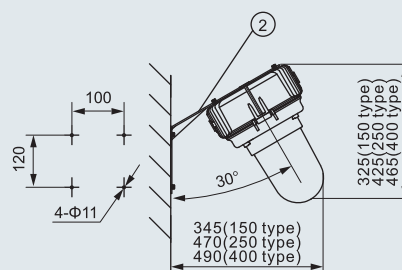

G: pendant pole type

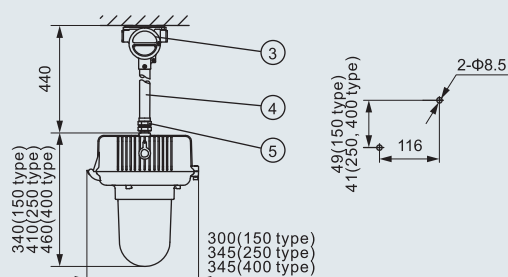

L: pole type 25°

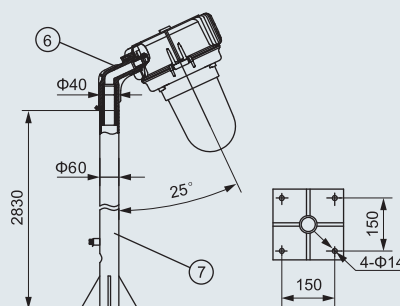

Mounting Accessories & Spare Parts Table

Supplied according to the mounting type

Mounting type	Accessories			Ordering	Weight (kg)
	Name	Qty	Illustration		
X: ceiling type	①.Mounting bracket	2	Powder coated carbon steel	81X02	0.20
			150 type	81B01	1.20
B: wall type	②.Wall bracket (powder coated carbon steel)	1	250 type	81B02	1.50
			400 type	81B02	1.50
			150 type: copper-free aluminium	BHD51-F	0.80
G: pendant pole type	③.BHD51-F Explosion-proof junction box	1	250,400 type: cast iron		2.10
	④.Straight pipe (M25 x 1.5)	1	Length: 300mm	81G01	0.41
	⑤.BGJ-III Explosion-proof connector	1	M25 x 1.5(M) / M25 x 1.5(F) Carbon steel	81D02	0.26
L: pole type 25°	⑥.Pole type 25° connector	1	Copper-free aluminium	81L02	0.80
	⑦.Pole	1	Φ60mm	81L03	-

Note: 1. Accessories not in the table shall be supplied by user.

2. Pole ⑦ shall not be supplied with light fittings; if required, please specify when ordering.

Accessories

Picture	Name	Ordering code	Weight (kg)	Picture	Name	Ordering code	Weight (kg)
	150 Wide reflector	81001	0.25		150 Deep reflector	81004	0.43
	250 Wide reflector	81002	0.35		250 Deep reflector	81005	0.63
	400 Wide reflector	81003	0.50		400 Deep reflector	81006	0.91

