

Pendant Light Fittings

BDD91 Series Explosion-proof Light Fittings



- ◆ Explosion protection to
 - CENELEC
 - IEC
 - NEC
- ◆ Can be used in
 - Zone 1 and Zone 2
 - Zone 21 and Zone 22
 - Class I, Zone 1 and Zone 2
 - Class I, Division 1, Groups A, B, C, D
- ◆ Applicable lamp (max.400W):
 - Metal halide lamp (HIE)
 - High pressure sodium lamp (HSE)
 - High pressure mercury lamp (HME)
- ◆ Three enclosure types: 150, 250, 400
- ◆ Integral control gear, easy installation and maintenance.

Catalogue number logic

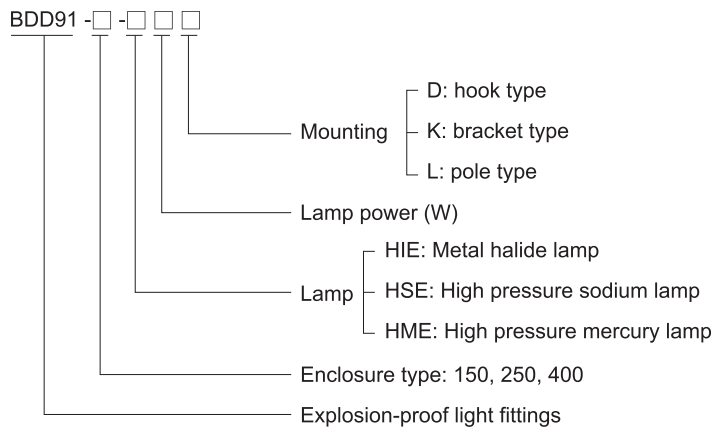

Selection table

Type/Ordering code	Available lamp power (W)			Lamp holder	Weight (kg)
	HIE	HSE	HME		
BDD91-150	70, 100, 150	70, 100	80, 125	E27	11.20
BDD91-250	175, 250	150, 250	175, 250	E40	14.80
BDD91-400	175, 250, 400	150, 250, 400	175, 400	E40	16.70

- Note:** 1. The light fittings are supplied without lamp. PHILIPS lamps are recommended.
 2. HPI European standard ballast is supplied with HIE light fitting. HPI European standard lamps are recommended.
 3. The light fittings are supplied without external reflector. Please specify when ordering.

Zones 1&2; 21&22

Pendant Light Fittings

BDD91 Series Explosion-proof Light Fittings

Technical data				
Explosion-proof light fittings		BDD91-150-□□□		
Explosion protection				
Gas explosion protection	Ex II 2 G Ex d IIC T□ ¹ Gb	Ex d IIC T□ ¹ Gb		
Dust explosion protection	Ex II 2 D Ex tb IIIC T□ ¹ Db IP66	Ex t IIIC T□ ¹ Db IP66		
	1) See Selection table			
Certificates	DNV 11 ATEX 05977X; IECEx CQM 12.0016X RU C-CN.ГБ05.В.00344 (CU-TR)			
Conformity to standards	EN 60079-0, EN 60079-1, EN 60079-31 IEC 60079-0, IEC 60079-1, IEC 60079-31			
Material				
Enclosure	Copper-free aluminium, powder coated surface, yellow (RAL1021)			
Transparent cover	Toughened glass, stands 4J impact			
Internal reflector	High-purity aluminium			
External reflector (optional)	Pure aluminium, anodic-oxidation treatment for surface			
Wire guard	Powder coated carbon steel (white)			
Ballast	Electromagnetic ballast, rapid starting, stable performance			
Trigger	General trigger			
Capacitor	Power factor ≥0.90 (compensated)			
Exposed fastener	Stainless steel			
Lamp	Available lamp			
Available lamp and lamp power (W)	HIE	HSE	HME	Lamp holder E27
	70W, 100W, 150W	70W, 100W	80W, 125W	
	Note: HPI European standard ballast is available in general.			
Rated voltage	220~240V AC 50Hz (60Hz is optional)			
Earthing protection	M5 (internal & external earth bolts)			
Degree of protection	IP66, IP67 (optional)			
Ambient temperature	-60°C~+55°C			
Terminal	3 x 1.5~4mm ² (L+N+PE)			
Mounting	Bracket type, pole type, hook type			
Cable entries	2 x M25x1.5 for bracket type, 1 x M25x1.5 for pole type.			
Cable gland (optional)	DQM-II (Ex d) or DQM-III (Ex d) is recommended. Please see P7/20~27			

Selection table (BDD91-150)			
Lamp	Lamp power (W)	Temperature classes	
		Gas	Dust
HIE	70, 100	T4	T130°C
HME	80		
HSE	70, 100		
HIE	150	T142°C	T142°C
HME	125	T147°C	T147°C



Pendant Light Fittings BDD91 Series Explosion-proof Light Fittings

Photometric data

BDD91-150-□□□(Without external reflector)



Rated luminous flux
 70W High pressure sodium lamp: 6600 lm
 100W High pressure sodium lamp: 10200 lm
 80W High pressure mercury lamp: 3800 lm
 125W High pressure mercury lamp: 6300 lm
 70W Metal halide lamp: 5000 lm
 100W Metal halide lamp: 9000 lm
 150W Metal halide lamp: 13500 lm
 The data from Philips lamp

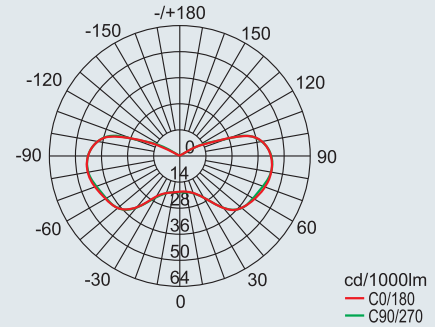

BDD91-150-□□□(With wide reflector)



Rated luminous flux
 70W High pressure sodium lamp: 6600 lm
 100W High pressure sodium lamp: 10200 lm
 80W High pressure mercury lamp: 3800 lm
 125W High pressure mercury lamp: 6300 lm
 70W Metal halide lamp: 5000 lm
 100W Metal halide lamp: 9000 lm
 150W Metal halide lamp: 13500 lm
 The data from Philips lamp

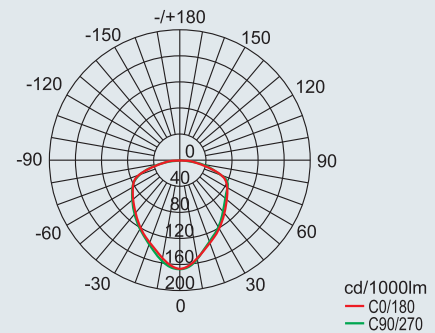

BDD91-150-□□□(With deep reflector)



Rated luminous flux
 70W High pressure sodium lamp: 6600 lm
 100W High pressure sodium lamp: 10200 lm
 80W High pressure mercury lamp: 3800 lm
 125W High pressure mercury lamp: 6300 lm
 70W Metal halide lamp: 5000 lm
 100W Metal halide lamp: 9000 lm
 150W Metal halide lamp: 13500 lm
 The data from Philips lamp

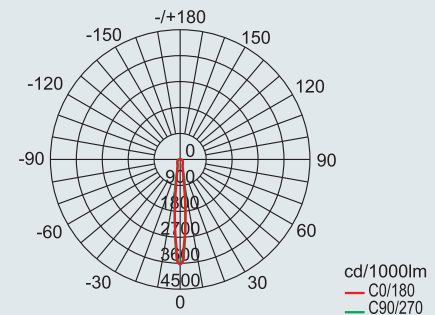

We can provide lighting design and data by professional lighting software DIALUX based upon simulated site situation on request.

Pendant Light Fittings

BDD91 Series Explosion-proof Light Fittings

Technical data			
Explosion-proof light fittings		BDD91-250-□□□	
Explosion protection	Gas explosion protection	Ex II 2 G Ex d IIC T3 Gb	Ex d IIC T3 Gb
	Dust explosion protection	Ex II 2 D Ex tb IIIC T190°C Db IP66	Ex t IIIC T190°C Db IP66
Certificates	DNV 11 ATEX 06159X; IECEx CQM 12.0016X RU C-CN.ГБ05.В.00344 (CU-TR)		
Conformity to standards	EN 60079-0, EN 60079-1, EN 60079-31 IEC 60079-0, IEC 60079-1, IEC 60079-31		
Material	Enclosure	Copper-free aluminium, powder coated surface, yellow (RAL1021)	
	Transparent cover	Toughened glass, stands 4J impact	
	Internal reflector	High-purity aluminium	
	External reflector (optional)	Pure aluminium, anodic-oxidation treatment for surface	
	Wire guard	Powder coated carbon steel (white)	
	Ballast	Electromagnetic ballast, rapid starting, stable performance	
	Trigger	General trigger	
	Capacitor	Power factor ≥ 0.90 (compensated)	
	Exposed fastener	Stainless steel	
Lamp	Available lamp and lamp power (W)	Available lamp	
		HIE	HSE
		175W, 250W	150W, 250W
		HME	Lamp holder
		175W, 250W	E40
Rated voltage	Note: HPI European standard ballast is available in general 220~240V AC 50Hz (60Hz is optional)		
Earthing protection	M5 (internal & external earth bolts)		
Degree of protection	IP66, IP67 (optional)		
Ambient temperature	-60°C~+55°C		
Terminal	3 x 1.5~4mm ² (L+N+PE)		
Mounting	Bracket type, pole type, hook type		
Cable entries	2 x M25x1.5 for bracket type, 1 x M25x1.5 for pole type.		
Cable gland (optional)	DQM-II (Ex d) or DQM-III (Ex d) is recommended. Please see P7/20~27.		



Pendant Light Fittings

BDD91 Series Explosion-proof Light Fittings

Photometric data

BDD91-250-□□□(Without external reflector)



Rated luminous flux
 175W Metal halide lamp: 16000 lm
 250W Metal halide lamp: 23500 lm
 150W High pressure sodium lamp: 18000 lm
 250W High pressure sodium lamp: 33200 lm
 175W High pressure mercury lamp: 7350 lm
 250W High pressure mercury lamp: 13000 lm
 The data from Philips lamp

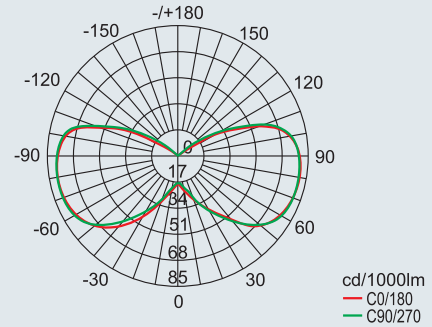

BDD91-250-□□□(With wide reflector)



Rated luminous flux
 175W Metal halide lamp: 16000 lm
 250W Metal halide lamp: 23500 lm
 150W High pressure sodium lamp: 18000 lm
 250W High pressure sodium lamp: 33200 lm
 175W High pressure mercury lamp: 7350 lm
 250W High pressure mercury lamp: 13000 lm
 The data from Philips lamp

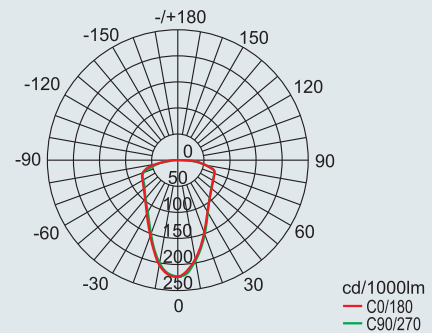

BDD91-250-□□□(With deep reflector)



Rated luminous flux
 175W Metal halide lamp: 16000 lm
 250W Metal halide lamp: 23500 lm
 150W High pressure sodium lamp: 18000 lm
 250W High pressure sodium lamp: 33200 lm
 175W High pressure mercury lamp: 7350 lm
 250W High pressure mercury lamp: 13000 lm
 The data from Philips lamp

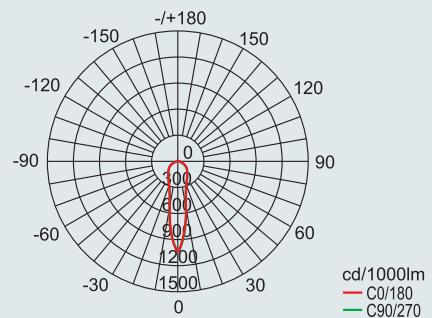

We can provide lighting design and data by professional lighting software DIALUX based upon simulated site situation on request.

Pendant Light Fittings

BDD91 Series Explosion-proof Light Fittings

Technical data				
Explosion-proof light fittings		BDD91-400-□□□		
Explosion protection	Gas explosion protection $\text{Ex II 2 G Ex d IIC T}\square^{1}\text{Gb}$ Dust explosion protection $\text{Ex II 2 D Ex tb IIIC T}\square^{1}\text{Db IP66}$ 1) See Selection Table			
Certificates	DNV 11 ATEX 06160X; IECEx CQM 12.0016X RU C-CN.ГБ05.В.00344 (CU-TR)			
Conformity to standards	EN 60079-0, EN 60079-1, EN 60079-31 IEC 60079-0, IEC 60079-1, IEC 60079-31			
Material	Enclosure Copper-free aluminium, powder coated surface, yellow (RAL1021) Transparent cover Toughened glass, stands 4J impact Internal reflector High-purity aluminium External reflector (optional) Pure aluminium, anodic-oxidation treatment for surface Wire guard Powder coated carbon steel (white) Ballast Electromagnetic ballast, rapid starting, stable performance Trigger General trigger Capacitor Power factor ≥ 0.90 (compensated) Exposed fastener Stainless steel			
Lamp	Available lamp			
Available lamp and lamp power (W)	HIE	HSE	HME	Lamp holder
	175W, 250W, 400W	150W, 250W, 400W	175W, 400W	E40
Rated voltage	Note: HPI European standard ballast is available in general. 220V, 230V, 240V AC 50Hz, 220~240V AC 50Hz (60Hz is optional)			
Earthing protection	M5 (internal & external earth bolts)			
Degree of protection	IP66, IP67 (optional)			
Ambient temperature	-60°C~+55°C			
Terminal	3 x 1.5~4mm ² (L+N+PE)			
Mounting	Bracket type, pole type, hook type			
Cable entries	2 x M25x1.5 for bracket type, 1 x M25x1.5 for pole type.			
Cable gland (optional)	DQM-II (Ex d) or DQM-III (Ex d) is recommended. Please see P7/20~27.			



Selection table					
Rated voltage (V)	Rated power (W)	Temperature classes			
		-60°C ≤ Ta ≤ 55°C		-60°C ≤ Ta ≤ 40°C	
		Gas	Dust	Gas	Dust
220V~240V AC 50/60Hz	HIE175W, 250W HSE150W	T4	T130°C	-	-
	HIE400W, HSE400W HME400W	T3	T190°C	-	-
220V AC 50/60Hz	HSE250W HME175W	T4	T130°C	-	-
230V/240V AC 50/60Hz	HSE250W HME175W	-	-	T4	T130°C

Pendant Light Fittings

BDD91 Series Explosion-proof Light fittings

Photometric data



BDD91-400-□□□(Without external reflector)

Rated luminous flux
 400W High pressure sodium lamp: 56500 lm
 400W High pressure mercury lamp: 22000 lm
 400W Metal halide lamp: 41000 lm
 The data from Philips lamp

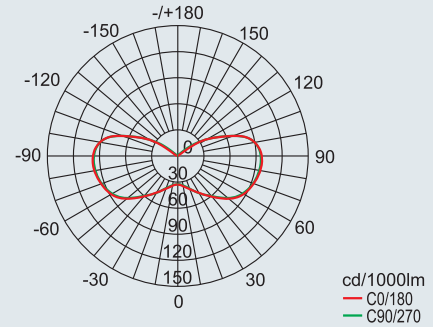

BDD91-400-□□□(With wide reflector)

Rated luminous flux
 400W High pressure sodium lamp: 56500 lm
 400W High pressure mercury lamp: 22000 lm
 400W Metal halide lamp: 41000 lm
 The data from Philips lamp

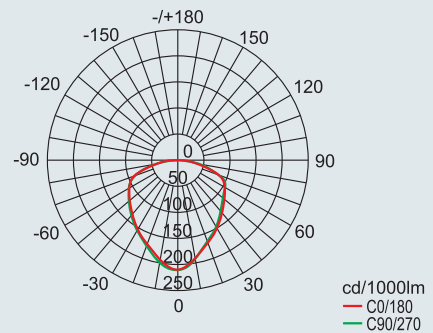

BDD91-400-□□□(With deep reflector)

Rated luminous flux
 400W High pressure sodium lamp: 56500 lm
 400W High pressure mercury lamp: 22000 lm
 400W Metal halide lamp: 41000 lm
 The data from Philips lamp

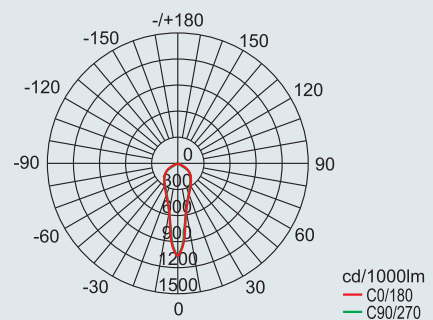

We can provide lighting design and data by professional lighting software DIALUX based upon simulated site situation on request.

Pendant Light Fittings BDD91 Series Explosion-proof Light fittings

Dimension drawings (all dimensions in mm) - subject to alteration

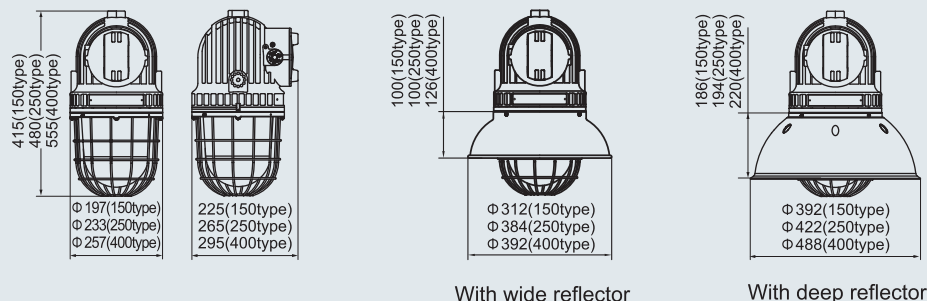

Mounting type (all dimensions in mm) – subject to alteration

Installation reference

K: bracket type

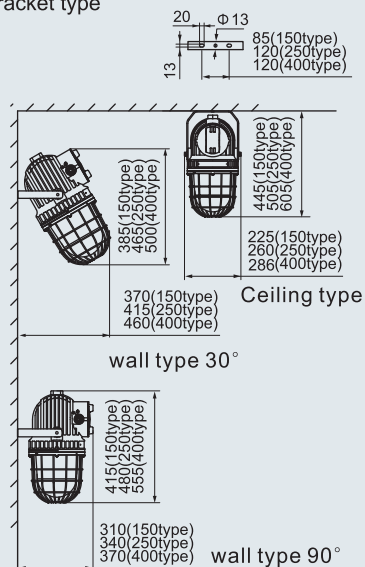

D: hook type

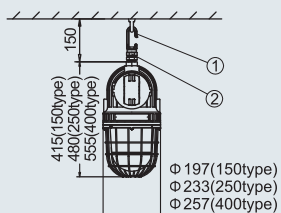

L: pole type (the pole is provided by user)

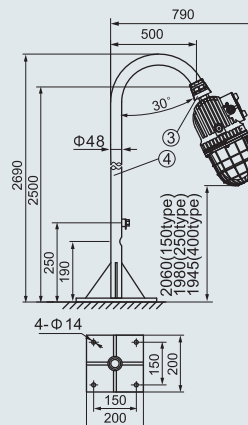

- ①. Hook (carbon steel).
- ②. BGJ-III explosion-proof connector, M25 x 1.5(M) / M25 x 1.5(F) carbon steel.
- ③. BGJ-III explosion-proof connector, M25 x 1.5(M) / M25 x 1.5(M) carbon steel.
- ④. Pole shall not be supplied with light fittings; if required, please specify when ordering.

Accessories

Picture	Name	Ordering code	Weight (kg)
	150 Wide reflector	91001	0.20
	250 Wide reflector	61002	0.27
	400 Wide reflector	91003	0.45
	150 Deep reflector	91004	0.44
	250 Deep reflector	91005	0.55
	400 Deep reflector	91006	0.65

Note: Ballast, trigger and capacitor see P1/19.

